

Model: GW12-650W(12V 200Ah)

# GW Series

VLRA High Rate Discharge Battery



Legacy Canadian products designed in Canada, assembled in China.

Connecting To Legacy

📍 Laval-Quebec-Canada

📍 Beirut-Lebanon

📍 Hongkong-China

🔍 [www.connectinglegacy.com](http://www.connectinglegacy.com)

Introduction	GW12-650W(12V 200Ah)
Length	522±2mm (20.6 inches)
Width	240±2mm (9.45 inches)
Height	219±2mm (8.62 inches)
Total Height	224±2mm (8.82 inches)
Weight	Approx. 58.0Kg (Tolerance±5%)
Terminal	Default F10(M8), Value: 10~12N*m
Container Material	A.B.S. UL94-HB, <UL94-V0 Optional>
Design Life	15 years
Application	UPS/EPS,Electric Tools,Toys,Medical,Wheelchair and Security System etc.

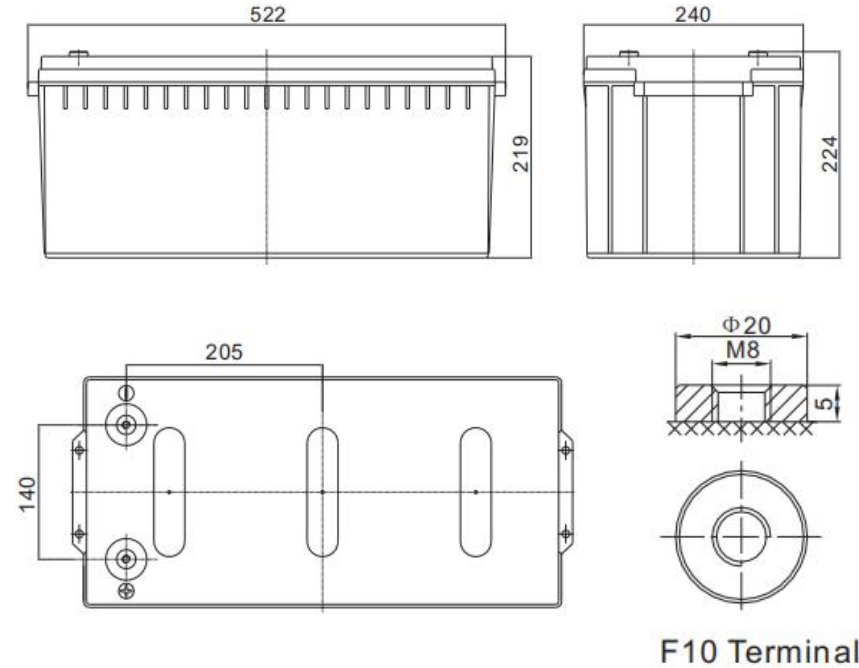

Structure: Compact design of shorter internal connectors among cells for lower I.R.

Plate: Pasted flat type with patent high rate formula of AM supports stable performance during high current discharge.

Features

Separator: Improved AGM separator increases deep cycle life.

Safety Valve:Flame arrester/filter is equipped with safety valve system.

Design and manufacture with DIN standards by Legacy team, for heavy load discharge applications.

GW12-650W Dimension

Parameters	GW12-650W (12V 200Ah)
Cell Per Unit	6
Voltage Per Unit	12V
Nominal Capacity	650W@15min-rate to 1.67V per cell @25°C
Internal Resistance	≤3.5 mΩ(Full Charge Condition @25°C)
Max. Discharge Current	2000A (5 sec)
Max. Charging Current	60.0A
Short Circuit Current	3850A
Reference Capacity	C10: 190.0Ah C20: 200.0Ah
Standby Use Voltage	13.50 V~13.62 V @ 25°C Temperature Compensation: -3mV/°C/Cell
Cycle Use Voltage	14.10 V~14.40 V @ 25°C Temperature Compensation: -4mV/°C/Cell
Normal Operating Temperature Range	25°C±5°C
Operating Temperature Range	Discharge and Storage : -20°C~60°C Charge: 0°C~50°C
Self Discharge	Monthly Self-discharge ratio is less than 3% at 25°C
Note	Legacy GW batteries can be stored for up to 6 months at 25°C and recharging is recommended. Please charged batteries before using.



GW12-650W Imagine

F.V/TIME	5 MIN	8 MIN	10 MIN	15 MIN	20 MIN	30 MIN	60 MIN	90 MIN
1.60V	573.4	500.6	457.1	359.5	292.7	215.7	124.9	89.60
1.65V	520.3	459.1	422.5	335.2	275.1	119.1	119.1	85.95
1.70V	498.2	441.3	407.3	325.0	267.4	116.7	116.7	84.29
1.75V	460.0	411.0	381.3	307.5	254.0	112.7	112.7	81.64
1.80V	421.4	380.7	356.4	290.9	242.1	108.6	108.6	78.98
1.85V	361.7	324.3	301.9	250.2	210.1	98.12	98.12	72.01



**Constant Current Discharge**  
Ah/Cell (@ 77°F/25°C)

Model: GW12-650W

F.V/TIME	5 MIN	8 MIN	10 MIN	15 MIN	20 MIN	30 MIN	60 MIN	90 MIN
1.60V	1054	932.3	859.8	685.2	562.5	419.2	234.5	169.6
1.65V	980.6	874.6	811.3	650.0	536.9	402.0	225.7	163.9
1.70V	948.3	848.4	788.7	634.9	525.3	393.9	222.0	161.6
1.75V	889.9	801.7	749.1	607.5	504.2	380.9	215.9	157.3
1.80V	828.3	752.6	707.4	580.5	485.2	367.5	209.4	153.0
1.85V	721.5	650.0	607.4	504.6	425.2	327.8	190.5	140.7



**Constant Power Discharge**  
W/Cell (@ 77°F/25°C)

### Discharge Characteristics Curve

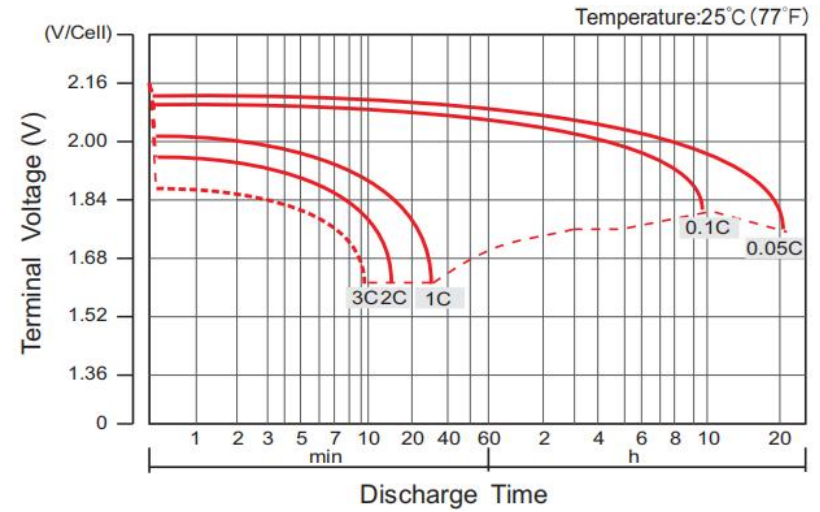

### Charge Characteristics Curve For Standby Use(IU)

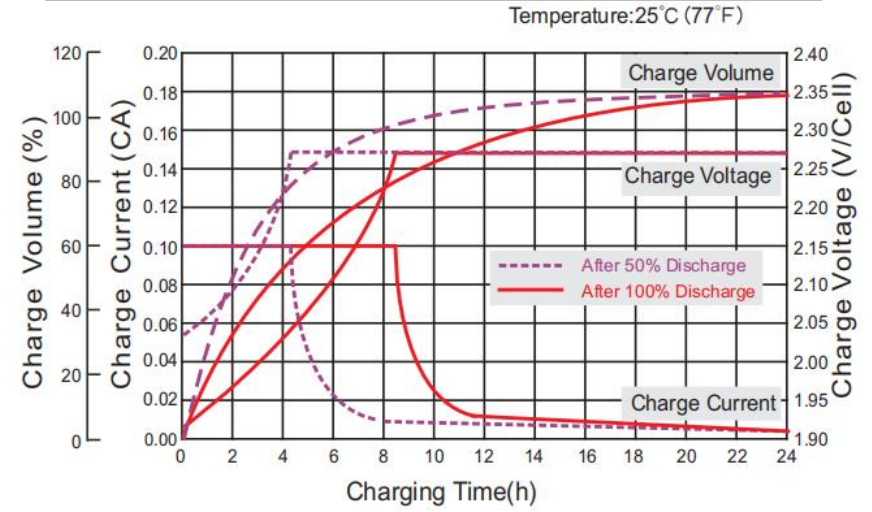

### Cycle Life in Relation to Depth of Discharge

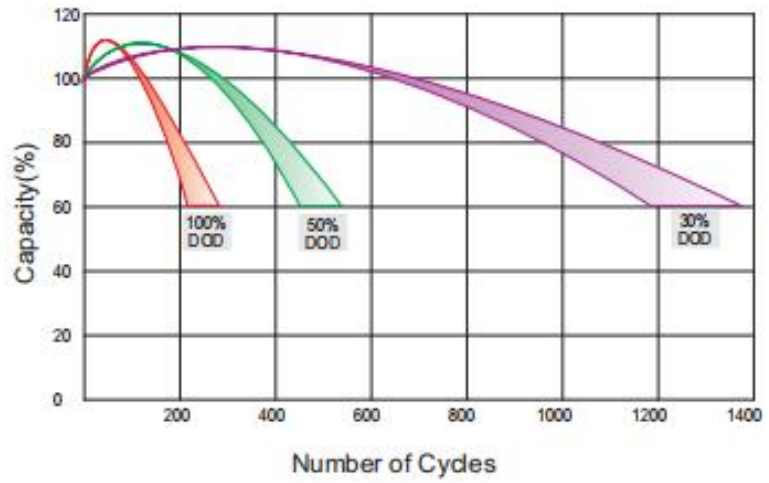

### Relationship Between Charging Voltage and Temperature

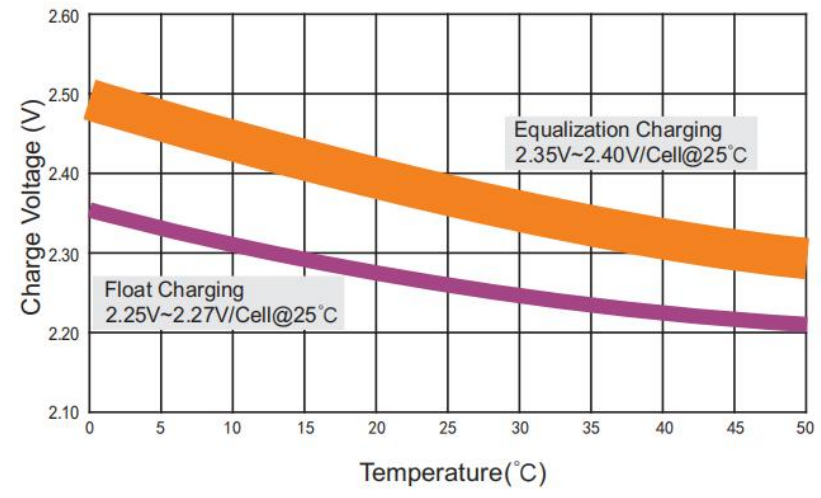

Note: The above data are average values, and can be obtained within 3 charge/discharge cycles. These are not minimum values. Cell and battery designs/specifications are subject to modification without notice. Legacy reserves the right to explain and update the latest information.

### Life Characteristics of Standby Use

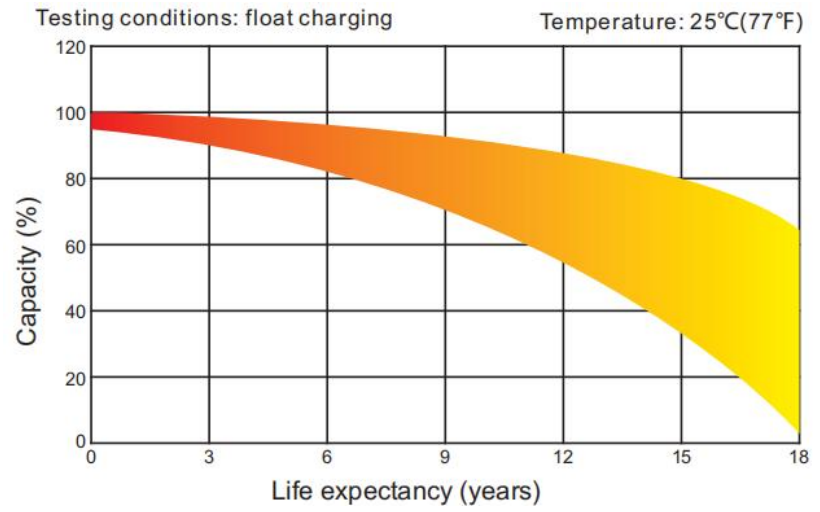

### Storage Characteristics

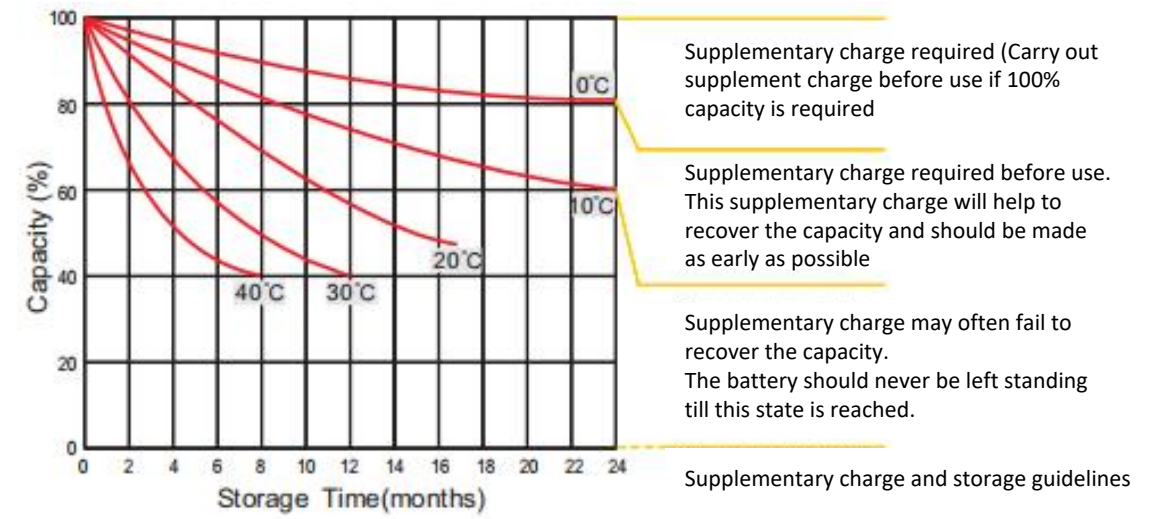

### Effect of Temperature on Longterm life

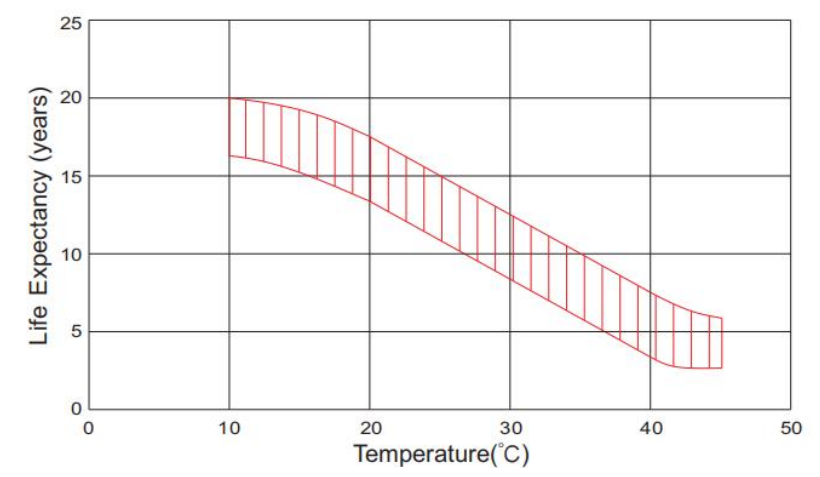

### Relationship of OCV and State of Charge(20°C)

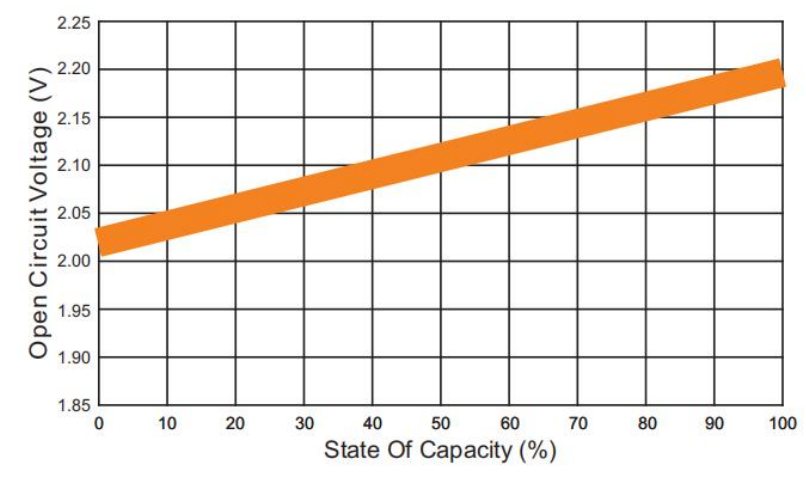

Note: The above data are average values, and can be obtained within 3 charge/ discharge cycles. These are not minimum values. Cell and battery designs/specifications are subject to modification without notice. Legacy reserves the right to explain and update the latest information.



# *LET'S DEVELOP TRUST AND BUSINESS*

*Connecting To Legacy*